

wagraf®

OD 1957 ROKU

KATALOG
PRODUKTÓW

2025



SPIS TREŚCI

Automaty stemplarskie	3
POLAN 1s, 2, 2s, 3, 3s, 4, 4s, 5, 5s	3
POLAN 55, 6, 6s, 7, 8	4
PIAST e-3, e-3s	4
WAGRAF b1s, b2, b2s, b3, b3s, b4, b4s, b17s	5
Tuszownice wymienne do automatów stemplarskich	6
Automaty stemplarskie okrągłe	7
Fi 10s, 20s, 30s, 40s	7
Datownik automatyczny plastikowy okrągły Fi D40s	7
Datowniki automatyczne plastikowe szkieletowe D230, D240	8
Automaty stemplarskie plastikowe szkieletowe 230, 240	8
Automaty stemplarskie metalowe	9
HUZAR 20, 30, 40, 50	9
HUZAR 60, 65, 80	10
Pudełka metalowe	11
Pudełka plastikowe	12
Datownik automatyczny plastikowy DATUŚ	13
Datowniki automatyczne metalowe	13
WAGRAF 100, 110	13
HUZAR D30, 140, D80	14
Uchwyty plastikowe do stempli	15
Uchwyty plastikowe tabelaryczne do stempli	16
Poduszki PM, PS, PD, PMD	17
Materiały eksploatacyjne do stempli polimerowych i laserowych	18
Pieczałka w 5 minut – stempel preink	19
Automaty stemplarskie WAGRAF a2, a3, a4, a6	19
Pudełka plastikowe WAGRAF nr 30, 31, 32	20
Materiały eksploatacyjne do stempli preink	21
Maszyny do naświetlania	22

Automaty stemplarskie POLAN

POLAN 1s	Compact	28x12mm
POLAN 2		39x15mm
POLAN 2s	Compact	39x15mm
POLAN 3		48x19mm
POLAN 3s	Compact	48x19mm
POLAN 4		59x25mm
POLAN 4s	Compact	59x25mm
POLAN 5		70x26mm
POLAN 5s	Compact	70x26mm



POLAN 1s



POLAN 2



POLAN 2s



POLAN 3



POLAN 3s



POLAN 4



POLAN 4s

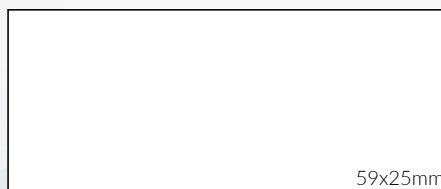

POLAN 5



POLAN 5s

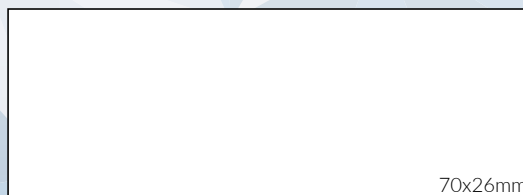

POLAN

POLAN 55		42x34mm
POLAN 6		69x29mm
POLAN 6s	Compact	69x29mm
POLAN 7		60x40mm
POLAN 8		75x40mm

POLAN 55

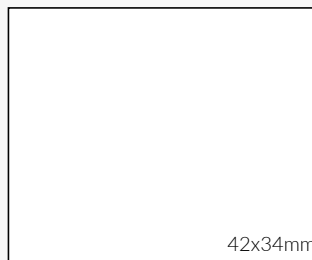

42x34mm

POLAN 6



POLAN 6s

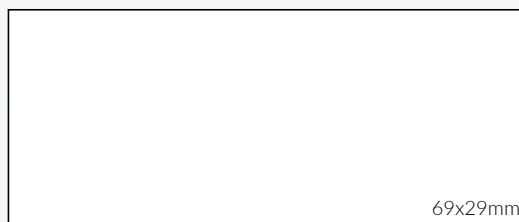

69x29mm

POLAN 7

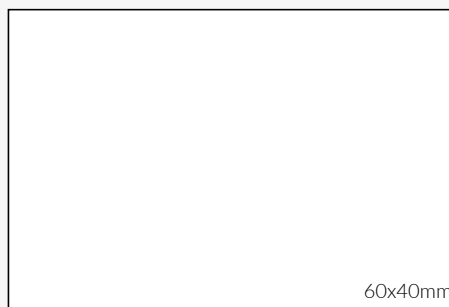

60x40mm

POLAN 8



75x40mm

PIAST e-3

PIAST e-3		50x25mm
PIAST e-3s	Compact	50x25mm

PIAST e-3



PIAST e-3s

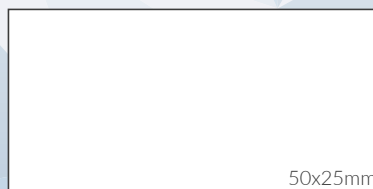

50x25mm

Automaty stemplarskie WAGRAF b

WAGRAF b1s	Compact	28x12mm
WAGRAF b2		39x15mm
WAGRAF b2s	Compact	39x15mm
WAGRAF b3		48x19mm
WAGRAF b3s	Compact	48x19mm
WAGRAF b4		59x25mm
WAGRAF b4s	Compact	59x25mm
WAGRAF b17s	Compact	70x10mm



WAGRAF b1s



WAGRAF b2



WAGRAF b2s

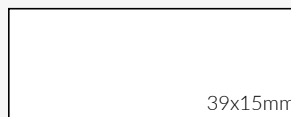

WAGRAF b3



WAGRAF b3s



WAGRAF b4



WAGRAF b4s



WAGRAF b17s



Tuszownice wymienne do automatów stemplarskich

TUSZOWNICE NASĄCZONE

tuszem w kolorach: czarny, czerwony, niebieski, zielony, fioletowy

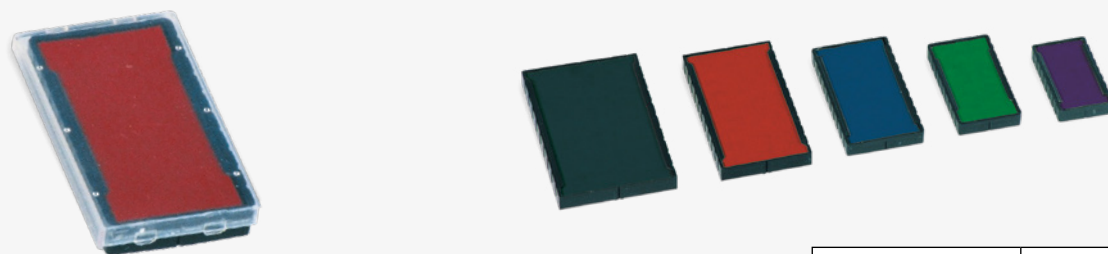

Istnieje możliwość zastosowania innego koloru tuszu do odbijania tekstu z płytki i innego do daty w datownikach WAGRAF D230 i D240, POLAN D55, POLAN D7.

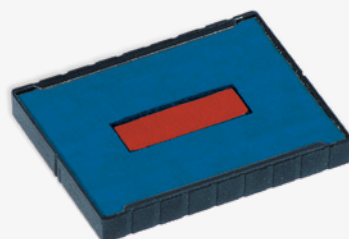

Do automatów Fi 10, Fi 20, Fi 30, Fi 40 i Fi D40 dostępne są tuszownice nasączone i nienasączone. Istnieje możliwość zastosowania innego koloru tuszu do odbijania tekstu z płytki i innego do daty w datowniku Fi D40.

TUSZOWNICE NIENASĄCZONE

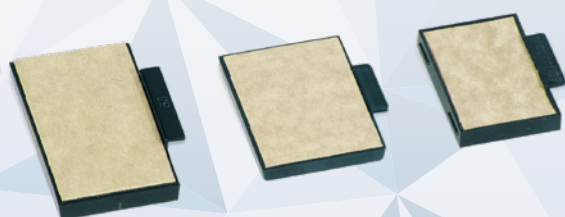

WAGRAF 1	28x10mm	■ ■ ■ ■ ■
POLAN 1 WAGRAF b1 DATUŚ	28x12mm	■ ■ ■ ■ ■
POLAN 2 WAGRAF b2 WAGRAF 2	39x15mm	■ ■ ■ ■ ■
POLAN 3 WAGRAF b3 WAGRAF 3	48x19mm	■ ■ ■ ■ ■
PIAST e-3	50x25mm	■ ■ ■ ■ ■
POLAN 4 WAGRAF b4 WAGRAF 4	59x25mm	■ ■ ■ ■ ■
WAGRAF b17	70x10mm	■ ■ ■ ■ ■
POLAN 5	70x26mm	■ ■ ■ ■ ■
POLAN 55 POLAN D55	42x34mm	■ ■ ■ ■ ■
POLAN 6	69x29mm	■ ■ ■ ■ ■
POLAN 7 POLAN D7	60x40mm	■ ■ ■ ■ ■
POLAN 8	75x40mm	■ ■ ■ ■ ■
Fi 10s	Ø 12mm	■ ■ ■ ■ ■
Fi 20s	Ø 22mm	■ ■ ■ ■ ■
Fi 30s	Ø 32mm	■ ■ ■ ■ ■
Fi 40s, Fi D40s	Ø 42mm	■ ■ ■ ■ ■
WAGRAF D230 WAGRAF 230	43x35mm	■ ■ ■ ■ ■
WAGRAF D240 WAGRAF 240	60x40mm	■ ■ ■ ■ ■
HUZAR 20	39x14mm	■ ■ ■ ■ ■
HUZAR 30 HUZAR D30	42x30mm	■ ■ ■ ■ ■
HUZAR 40	55x23mm	■ ■ ■ ■ ■
HUZAR 50	58x35mm	■ ■ ■ ■ ■
HUZAR 60	70x24mm	■ ■ ■ ■ ■
HUZAR 80 HUZAR D80	70x48mm	■ ■ ■ ■ ■
WAGRAF 100	42x25mm	■ ■ ■ ■ ■
HUZAR 65 HUZAR 140	58x35mm	■ ■ ■ ■ ■

Automaty stemplarskie okrągłe

fi 10s, fi 20s, fi 30s, fi 40s

Fi 10s	Compact	Ø 12mm
Fi 20s	Compact	Ø 22mm
Fi 30s	Compact	Ø 32mm
Fi 40s	Compact	Ø 42mm

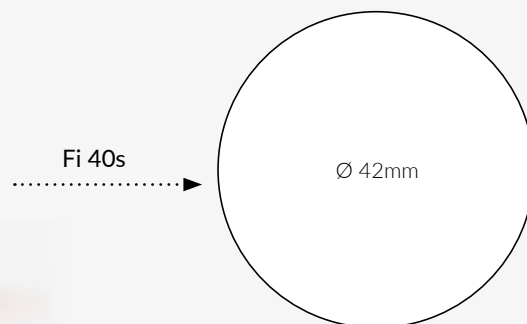
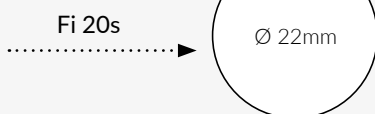

Datownik automatyczny plastikowy okrągły

fi D40s

Fi D40s	Compact	Ø 42mm
---------	---------	--------

Datownik Fi D40 występuje w wersjach:

- miesiące pisane słownie
2025 STY. 01
01 STY. 2025
- miesiące pisane cyframi
2025-01-01
01-01-2025

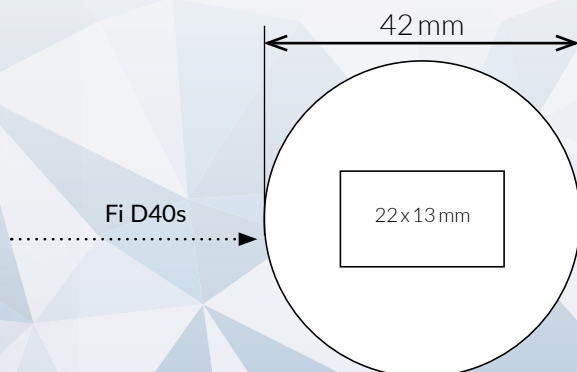

stempluj i datuj na okrągło

W automatach D230, D 240, 230 i 240 elementy szkieletowe są w 2 kolorach ● ● a pozostałe elementy plastikowe w 12 KOLORACH ● ● ● ● ● ● ● ● ● ● ● ●

Datowniki automatyczne plastikowe szkieletowe



WAGRAF D230

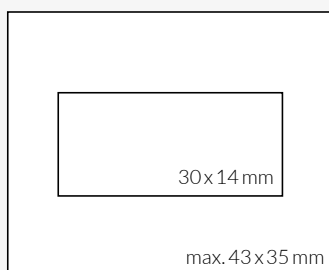

WAGRAF D240

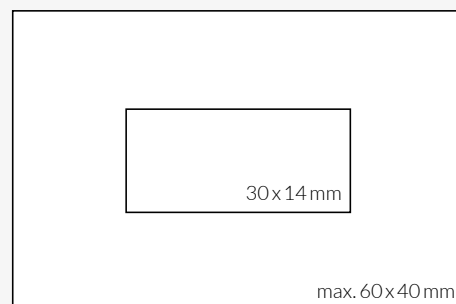

WAGRAF D230	43x35mm
WAGRAF D240	60x40mm

Datowniki automatyczne plastikowe szkieletowe pozwalają na zamieszczenie w odbiciu pieczęci

- daty
- tekstu dowolnej treści.

Istnieje możliwość zastosowania innego koloru tuszu do odbijania tekstu z płytki i innego do daty.

Datowniki D230 i D240 występują w wersjach:

- miesiące pisane cyframi
2025-01-01
01-01-2025

Automaty stemplarskie plastikowe szkieletowe



WAGRAF 230

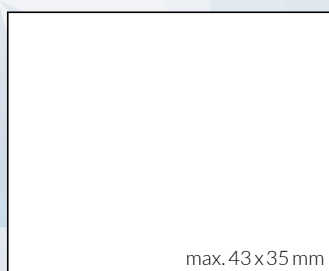

WAGRAF 240



WAGRAF 230	43x35mm
WAGRAF 240	60x40mm

Automaty stemplarskie metalowe

HUZAR 20	metalowy	39x14mm
HUZAR 30	metalowy	42x30mm
HUZAR 40	metalowy	55x23mm
HUZAR 50	metalowy	58x30mm

huzar®



huzar®
HUZAR 20 ←

huzar®

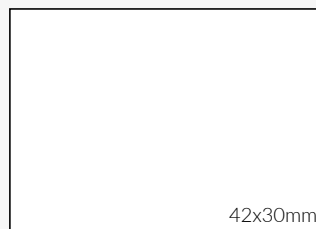

huzar®
HUZAR 30 ←

huzar®



huzar®
HUZAR 40 ←

huzar®

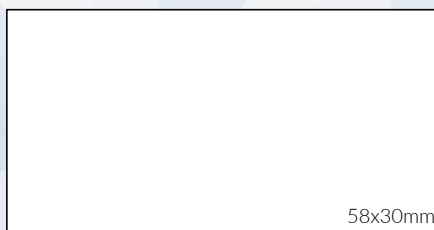

huzar®
HUZAR 50 ←

Huzar® to najnowszy model stempla ręcznego, zgłoszony do ochrony w Urzędzie Patentowym Rzeczypospolitej Polskiej Nr P-368177 i chroniony w krajach Unii Europejskiej i USA z ważnością od dnia 24.05.2004.

solidne stemplowanie

Automaty stemplarskie metalowe



HUZAR 60

HUZAR 60	metalowy	70x24mm
HUZAR 65	metalowy	58x35mm
HUZAR 80	metalowy	70x48mm

huzar®



70x24mm



huzar®



HUZAR 65



58x35mm

huzar®



HUZAR 80



70x48mm

Pudełko metalowe



Pudełko	nr 1	38x15mm
Pudełko	nr 1,5	48x13mm
Pudełko	nr 1 3/4	38x20mm
Pudełko	nr 2 I	48x17mm
Pudełko	nr 2 II	46x18mm
Pudełko	nr 2,5	48x20mm
Pudełko	nr 2 3/4 I	48x23mm
Pudełko	nr 2 3/4 II	50x28mm
Pudełko	nr 3	58x19mm
Pudełko	nr 3,5	58x23mm
Pudełko	nr 4	58x26mm
Pudełko	nr 4,5	60x34mm
Pudełko	nr 5	50x50mm
Pudełko	nr 0	26x23mm
Pudełko	nr 01	31x31mm

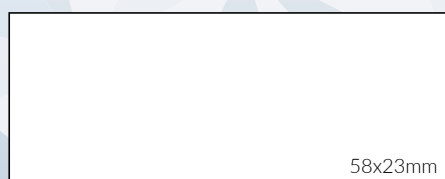
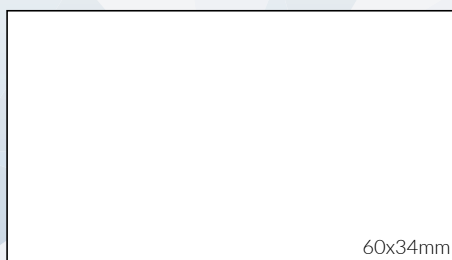
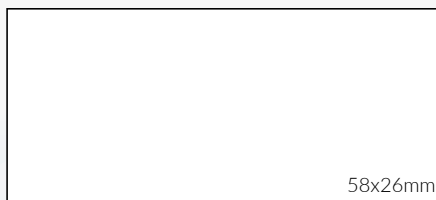
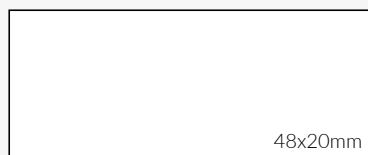
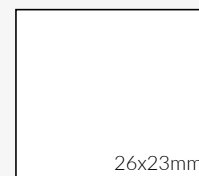
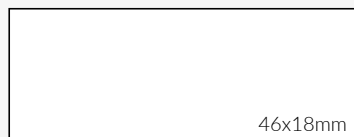
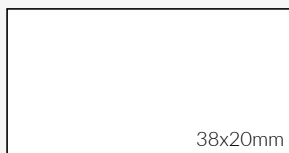

Datownik automatyczny plastikowy



DATUŚ
bez płytki



DATUŚ	bez płytki
-------	------------

Datownik DATUŚ występuje w wersjach:

- miesiące pisane słownie
2025 STY. 01
01 STY. 2025
- miesiące pisane cyframi
2025 - 01 - 01
01-01-2025

Datowniki automatyczne metalowe

WAGRAF 100		42x25mm
WAGRAF 110	bez płytki	



WAGRAF 100

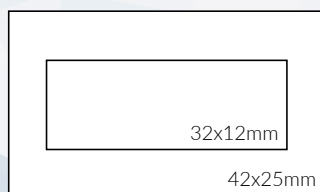

WAGRAF 110
bez płytki

Datowniki WAGRAF 100 i 110 występują w wersjach:

- miesiące pisane cyframi
2025 - 01 - 01
01-01-2025

Datowniki automatyczne metalowe

HUZAR D30	42x30mm
HUZAR 140	58x35mm
HUZAR D80	70x48mm



HUZAR D30

huzar®

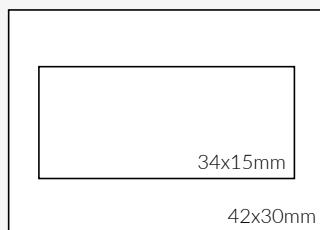

Datowniki automatyczne metalowe pozwalają na zamieszczenie w odbiciu pieczętki

- daty
- tekstu dowolnej treści.

Istnieje możliwość zastosowania innego koloru tuszu do odbijania tekstu z płytki i innego do daty.

Datowniki automatyczne metalowe występują w wersjach:

- miesiące pisane cyframi
2025 - 01 - 01
01-01-2025



HUZAR 140

huzar®

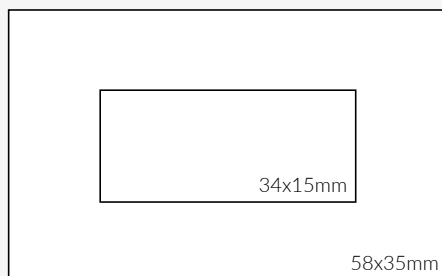

HUZAR D80

huzar®

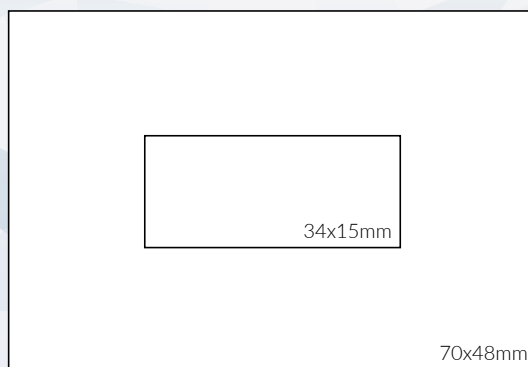

Uchwyty plastikowe do stempli

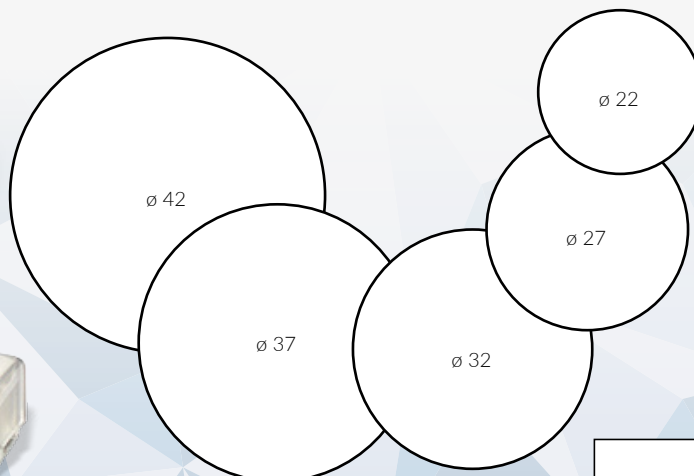
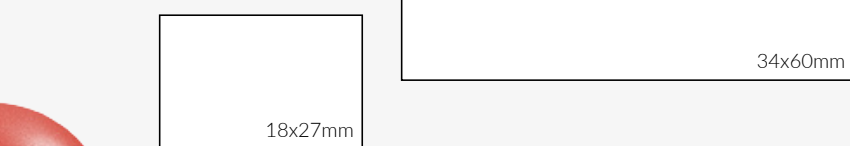
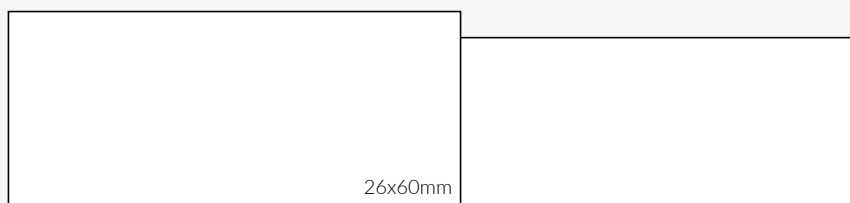
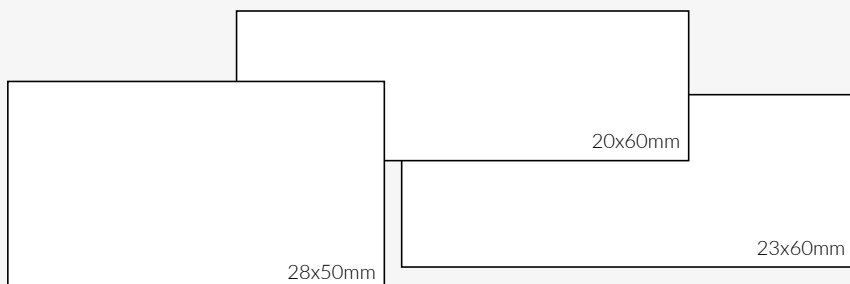
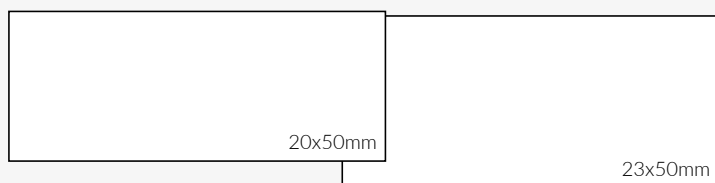
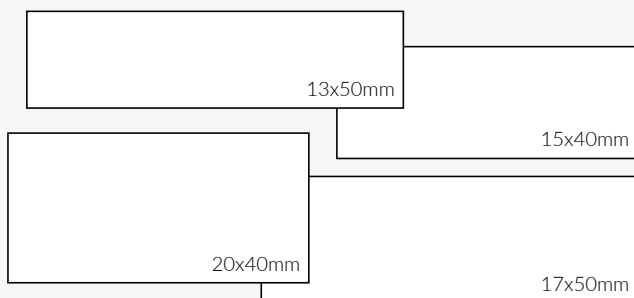

Uchwyt	nr 1	15x40mm
Uchwyt	nr 1,5	13x50mm
Uchwyt	nr 1 3/4	20x40mm
Uchwyt	nr 2	17x50mm
Uchwyt	nr 2,5	20x50mm
Uchwyt	nr 2 3/4	23x50mm
Uchwyt	nr 2 3/4 II	28x50mm
Uchwyt	nr 3	20x60mm
Uchwyt	nr 3,5	23x60mm
Uchwyt	nr 4	26x60mm
Uchwyt	nr 4,5	34x60mm
Uchwyt	nr 0	18x27mm
Uchwyt	nr 740	7x40mm
Uchwyt	nr 745	7x45mm
Uchwyt	nr 750	7x50mm
Uchwyt	nr 755	7x55mm
Uchwyt	okrągły	Ø 22
Uchwyt	okrągły	Ø 27
Uchwyt	okrągły	Ø 32
Uchwyt	okrągły	Ø 37
Uchwyt	okrągły	Ø 42
Uchwyt	nr 1040	10x40mm
Uchwyt	nr 1045	10x45mm
Uchwyt	nr 1055	10x55mm
Uchwyt	nr 1070	10x70mm

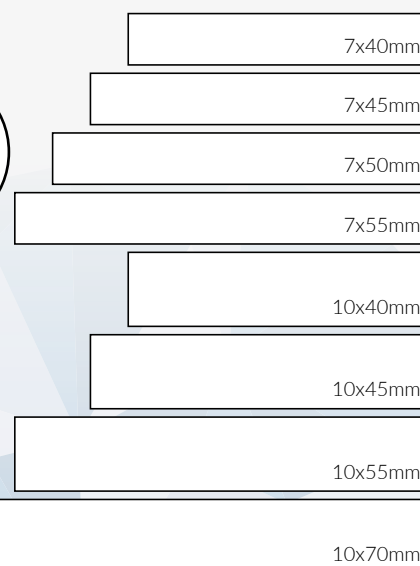

Uchwyty plastikowe tabelaryczne do stempeli

Uchwyt	nr 4075	40x75mm
Uchwyt	nr 4565	45x65mm
Uchwyt	nr 5555	55x55mm
Uchwyt	nr 5565	55x65mm
Uchwyt	nr 5575	55x75mm
Uchwyt	nr 6565	65x65mm

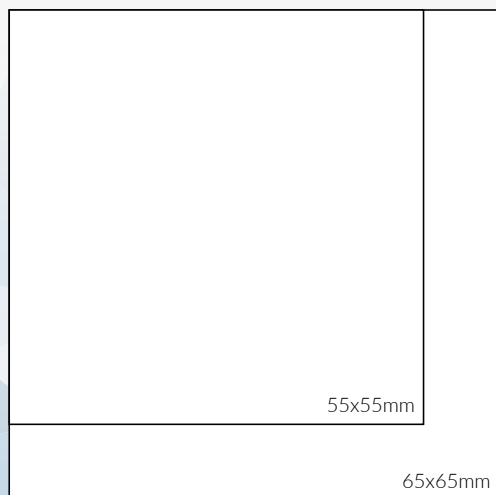
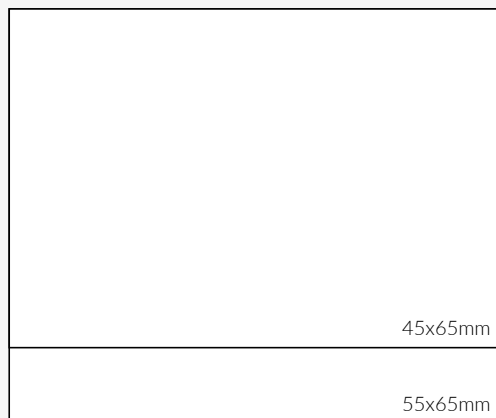

Uchwyt	nr 7090	70x90mm
Uchwyt	nr 80100	80x100mm
Uchwyt	nr 90110	90x110mm

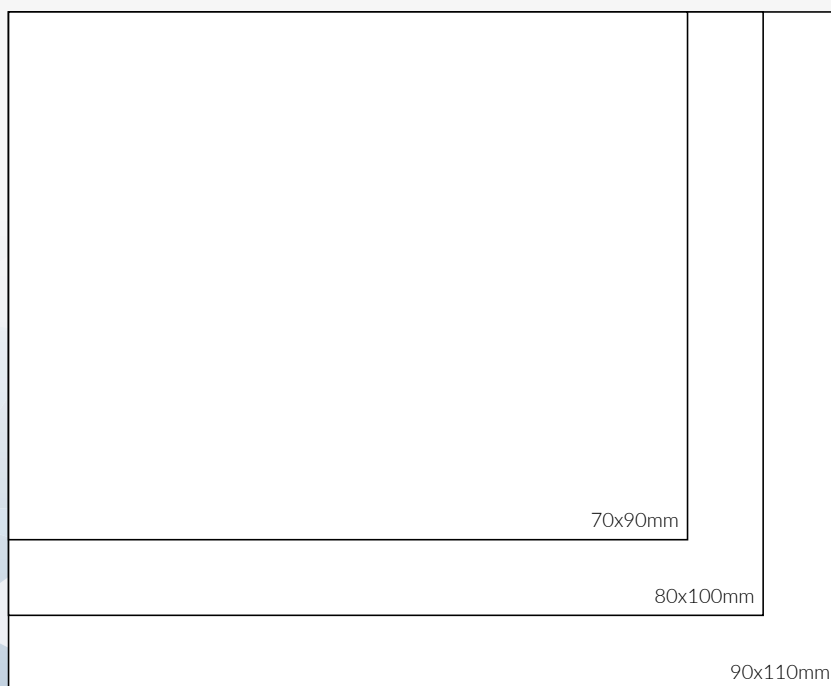

Poduszki



PM
poduszka mała (plastikowa) – 50 x 85 mm

PM	50x85mm
PS	70x110mm
PD	85x155mm
PMD	190x110mm

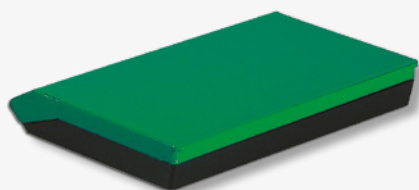

PS
poduszka średnia (plastikowa) – 70 x 110 mm

Poduszki plastikowe
PD, PS, PM
są nasączone tuszem.

Kolor pokrywki określa
kolor tuszu (czarny, **niebieski**,
czzerwony, **fioletowy**, **zielony**).



PD
poduszka duża (plastikowa) – 85 x 155 mm



PMD
poduszka metalowa duża – 190 x 110 mm

Poduszka metalowa PMD
– to poduszka sucha
do samodzielnego
napełniania tuszem.

Materiały eksploatacyjne do stempli polimerowych i laserowych



Fotopolimer 1 kg



Wywoływacz 1 kg



Utrwalacz 1 kg



Płyn do płukania 1 kg



Folia nośna



Folia ochronna



Kalka do wydruku, laser film



Film UV



Uszczelka (grubość 2 i 3 mm)

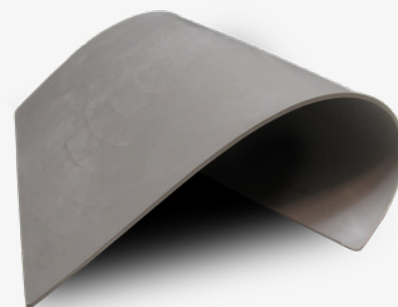

Guma do lasera



Tusz polimerowy 25 ml

Pieczętka w 5 minut

Stempel preink

AUTOMATY STEMPLARSKIE

WAGRAF a2	preink	40x15mm
WAGRAF a3	preink	49x19mm
WAGRAF a4	preink	60x23mm
WAGRAF a6	preink	67x38mm

Do automatów a2, a3, a4 i a6 dostępne są odpowiednie materiały do naświetlania.



WAGRAF a2

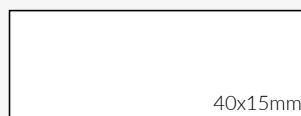

40x15mm



WAGRAF a3

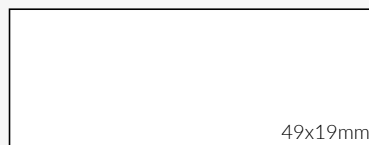

49x19mm



WAGRAF a4



60x23mm



WAGRAF a6

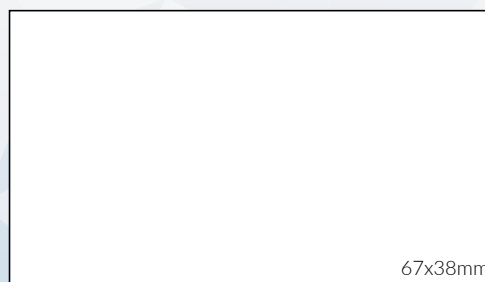

67x38mm

Pieczętka w 5 minut

Stempel preink

PUDEŁKA PLASTIKOWE



PUDEŁKO nr 30	preink	40x15mm
PUDEŁKO nr 31	preink	49x19mm
PUDEŁKO nr 32	preink	60x23mm

Do pudełek nr 30, 31 i 32 dostępne są odpowiednie materiały do naświetlania.

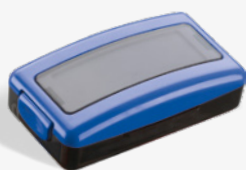

PUDEŁKO nr 30



PUDEŁKO nr 31



PUDEŁKO nr 32

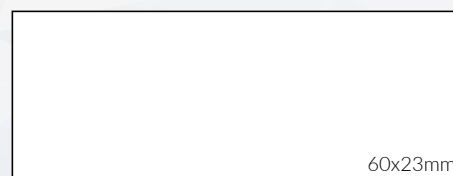

Materiały eksploatacyjne do stempli preink



Kalka do wydruku, laser film



Folia ochronna

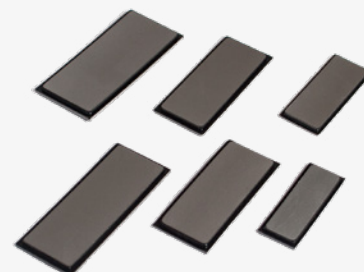

Materiał do naświetlania



Tusz do stempli w butelkach 30ml



Cartridge kolorowe do stempli

WAGRAF a2 PUDEŁKO nr 30	preink	40x15mm
WAGRAF a3 PUDEŁKO nr 31	preink	49x19mm
WAGRAF a4 PUDEŁKO nr 32	preink	60x23mm
WAGRAF a6	preink	67x38mm

Maszyny do naświetlania do **stempli preink**



MQ B1308 1 lampa



MQ B1409



MQ B1511

Zakład Mechaniczny
wagraf®

04-608 Warszawa – Anin, ul. Stradomska 56A

tel. 22 812 12 34

22 815 62 83

22 815 33 01

22 815 63 05

22 812 45 62

22 815 38 53

www.wagraf.pl

